

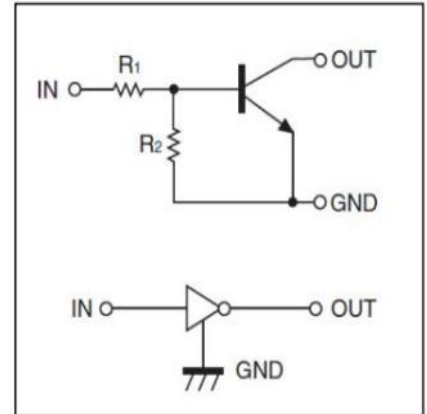

DTC114Yxx Digital Transistors (Built-in Resistors)

• **Equivalent Circuit**

DIGITAL TRANSISTOR (NPN)



FEATURES

- Built-in bias resistors enable the configuration of an inverter circuit without connecting external input resistors(see equivalent circuit)
- The bias resistors consist of thin-film resistors with complete isolation to allow negative biasing of the input.They also have the advantage of almost completely eliminating parasitic effects
- Only the on/off conditions need to be set for operation, making device design easy

PIN CONNENCTIONS and MARKING

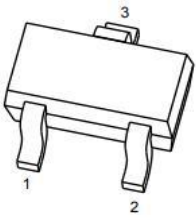
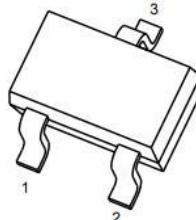
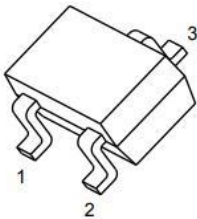
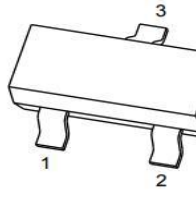
<p>DTC114YE</p>  <p>SOT-523</p> <p>1. IN 2. GND 3. OUT</p>	<p>DTC114YUA</p>  <p>SOT-323</p> <p>1. IN 2. GND 3. OUT</p>
<p>DTC114YKA</p>  <p>SOT-23-3L</p> <p>1. IN 2. GND 3. OUT</p>	<p>DTC114YCA</p>  <p>SOT-23</p> <p>1. IN 2. GND 3. OUT</p>

ORDERING INFORMATION

Part Number	MARKING	Package	Packing Method	Pack Quantity
DTC114YE	64	SOT-523	Reel	3000pcs/Reel
DTC114YUA	64	SOT-323	Reel	3000pcs/Reel
DTC114YKA	64	SOT-23-3L	Reel	3000pcs/Reel
DTC114YCA	64	SOT-23	Reel	3000pcs/Reel



MAXIMUM RATINGS(Ta=25°C unless otherwise noted)

Symbol	Parameter	Limits(DTC114Y□)						Unit
		M	E	UA	KA	CA	SA	
V _{CC}	Supply Voltage	50						V
V _{IN}	Input Voltage	-6~+40						V
I _O	Output Current	70						mA
I _{CM}	Peak Collector Current	100						mA
P _D	Power Dissipation	100	150	200	200	200	300	mW
T _J , T _{stg}	Operation Junction and Storage Temperature Range	-55~+150						°C

ELECTRICAL CHARACTERISTICS (Ta=25°C unless otherwise specified)

Parameter	Symbol	Conditions	Min	Typ	Max	Unit
Input voltage	V _{I(off)}	V _{CC} =5V, I _O =100μA			0.3	V
	V _{I(on)}	V _O =0.3V, I _O =1mA	1.4			V
Output voltage	V _{O(on)}	I _O /I _I =5mA/0.25mA			0.3	V
Input current	I _I	V _I =5V			0.88	mA
Output current	I _{O(off)}	V _{CC} =50V, V _I =0			0.5	μA
DC current gain	G _I	V _O =5V, I _O =5mA	68			
Input resistance	R ₁		7	10	13	kΩ
Resistance ratio	R ₂ /R ₁		3.7	4.7	5.7	
Transition frequency	f _T	V _O =10V, I _O =5mA, f=100MHz		250		MHz



Typical Characteristics

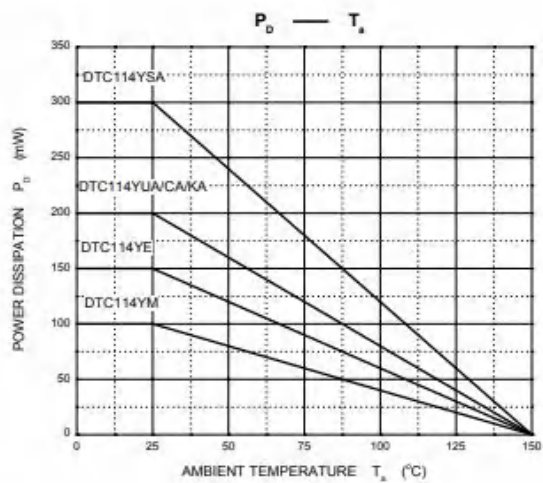
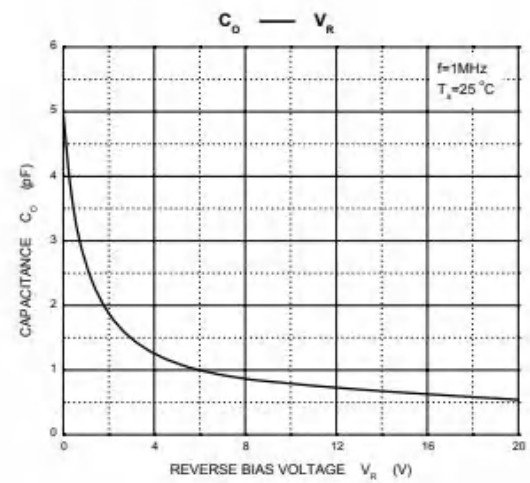
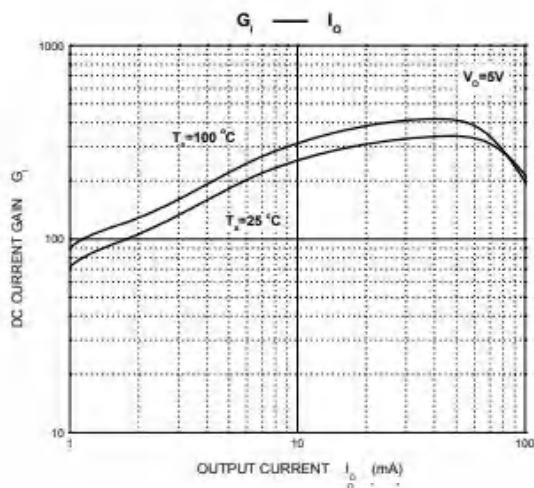
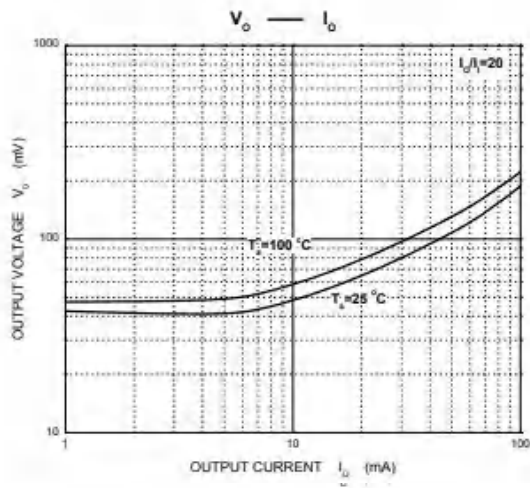
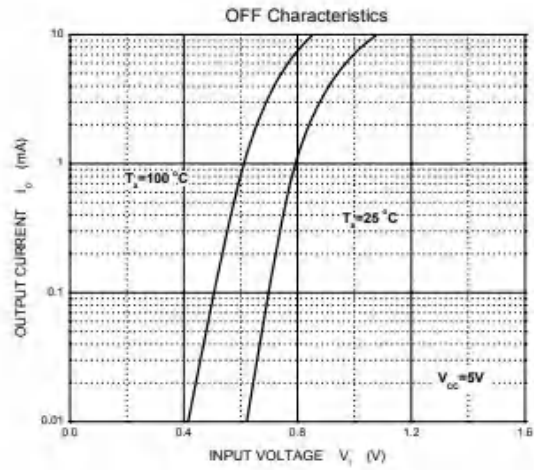
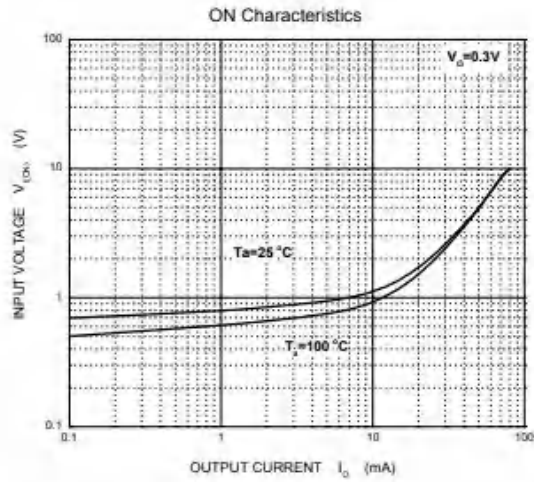



SOT-23 PACKAGE OUTLINE

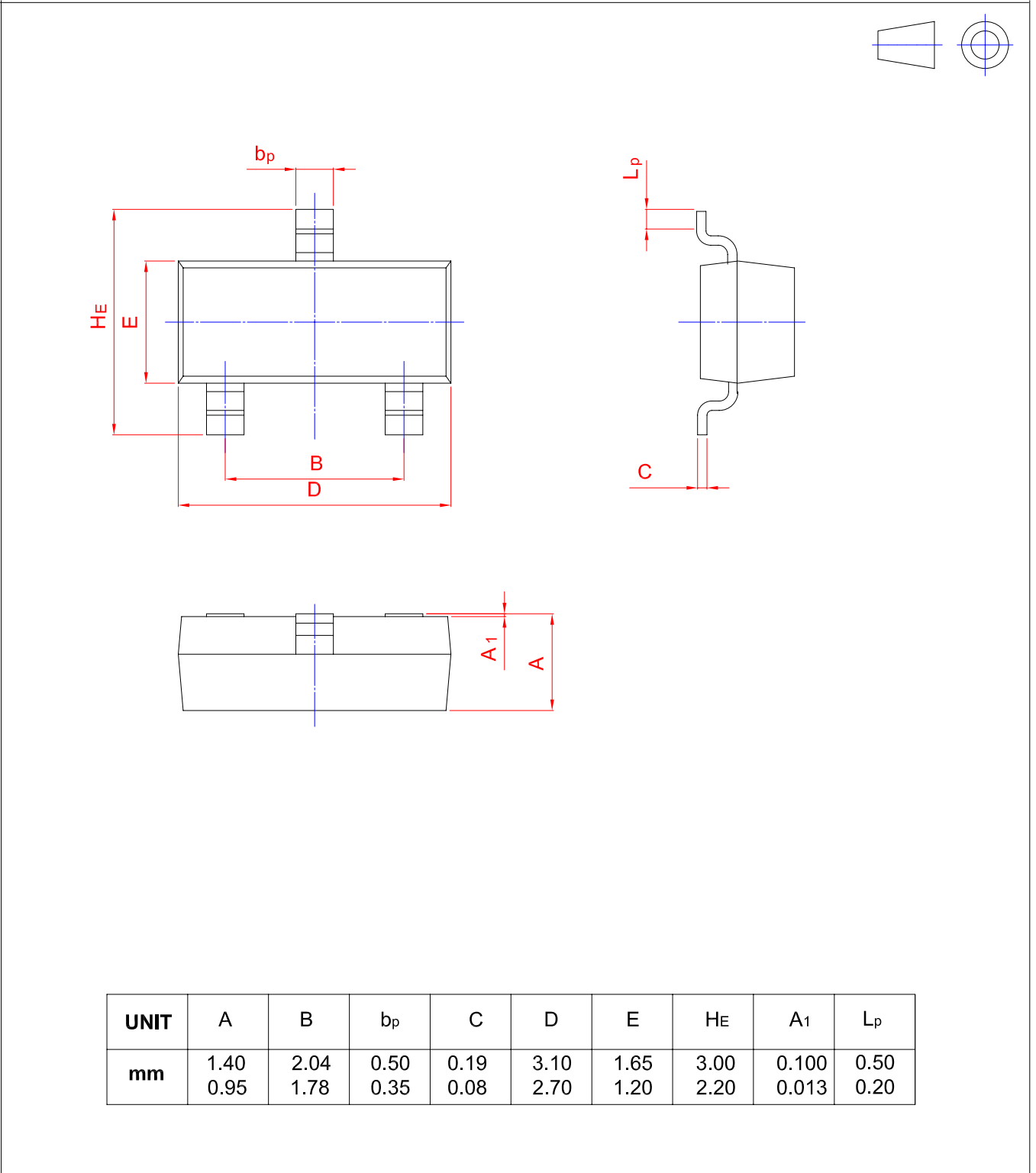



SOT-523 Package Outline Dimensions

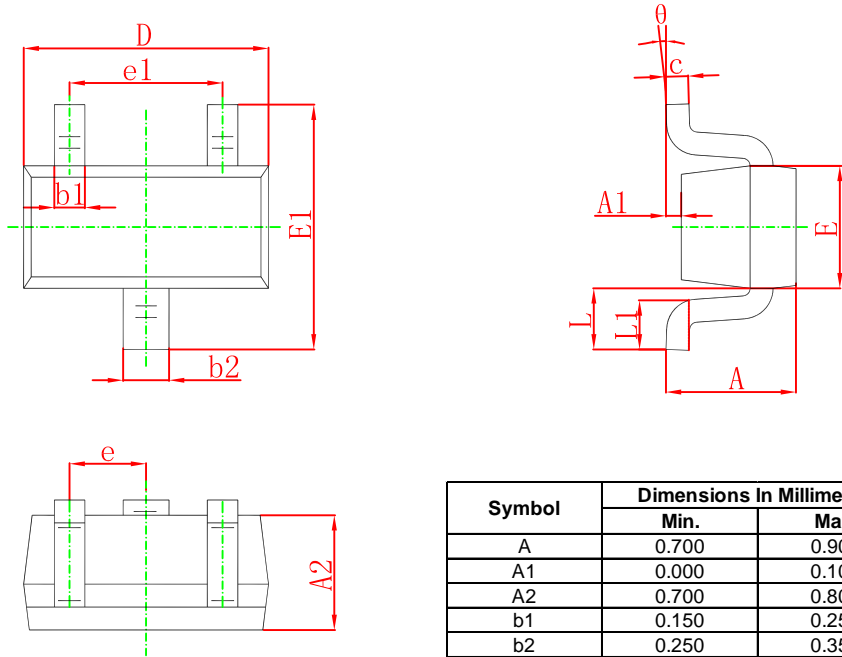

Symbol	Dimensions In Millimeters		Dimensions In Inches	
	Min.	Max.	Min.	Max.
A	0.700	0.900	0.028	0.035
A1	0.000	0.100	0.000	0.004
A2	0.700	0.800	0.028	0.031
b1	0.150	0.250	0.006	0.010
b2	0.250	0.350	0.010	0.014
c	0.100	0.200	0.004	0.008
D	1.500	1.700	0.059	0.067
E	0.700	0.900	0.028	0.035
E1	1.450	1.750	0.057	0.069
e	0.500 TYP.		0.020 TYP.	
e1	0.900	1.100	0.035	0.043
L	0.400 REF.		0.016 REF.	
L1	0.260	0.460	0.010	0.018
θ	0°	8°	0°	8°

SOT-523 Suggested Pad Layout

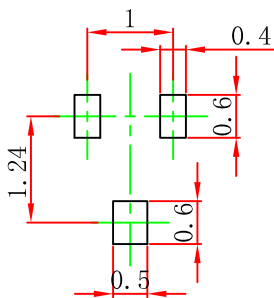

- Note:
1. Controlling dimension: in millimeters.
 2. General tolerance: $\pm 0.05\text{mm}$.
 3. The pad layout is for reference purposes only.



SOT-323 PACKAGE OUTLINE DIMENSIONS

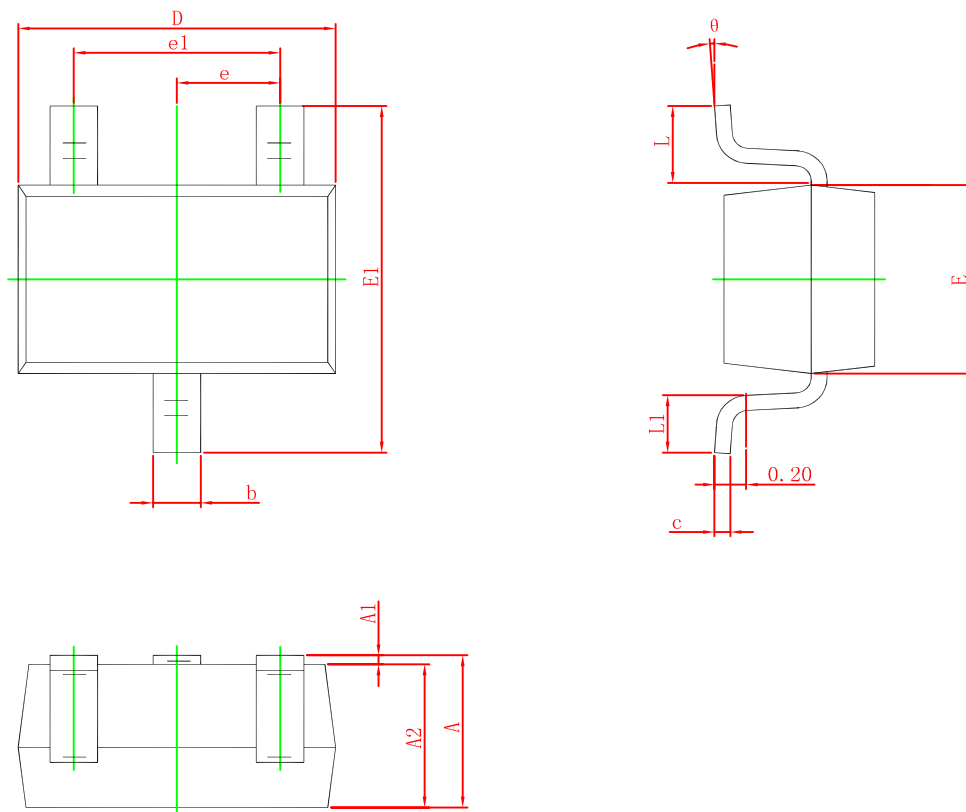

Symbol	Dimensions In Millimeters		Dimensions In Inches	
	Min.	Max.	Min.	Max.
A	0.900	1.100	0.035	0.043
A1	0.000	0.100	0.000	0.004
A2	0.900	1.000	0.035	0.039
b	0.200	0.400	0.008	0.016
c	0.080	0.150	0.003	0.006
D	2.000	2.200	0.079	0.087
E	1.150	1.350	0.045	0.053
E1	2.150	2.450	0.085	0.096
e	0.650 TYP.		0.026 TYP.	
e1	1.200	1.400	0.047	0.055
L	0.525 REF.		0.021 REF.	
L1	0.260	0.460	0.010	0.018
θ	0°	8°	0°	8°